

DBB

DHN-72R20

610~630W

High Efficiency Single Glass PV Module

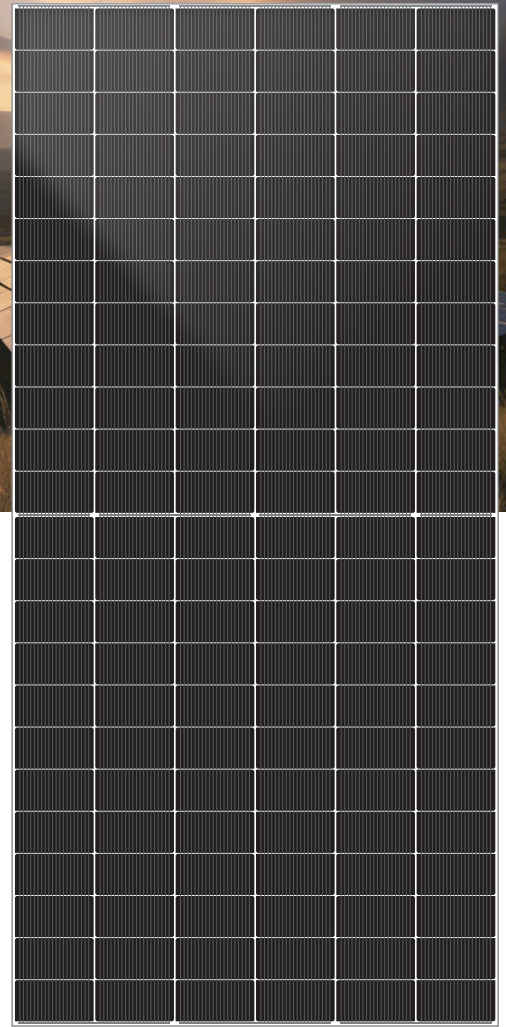



Comprehensive Products & System Certificates

IEC 61215 / IEC 61730 / CE / INMETRO
ISO 45001
2018/International standards for occupational health & safety
ISO 14001
2015/Standards for environmental management system
ISO 9001
2015/Quality management system

 Material & technology warranty

 Linear power output warranty

No-Busbar(OBB) Technology, shorten 40% of the transmission distance.
Reduces losses & improving conversion efficiency



Higher power, longer service life, linear power warranty for 30 years

TOPCon cells, lower attenuation,
better temperature coefficient & dim ligh performance

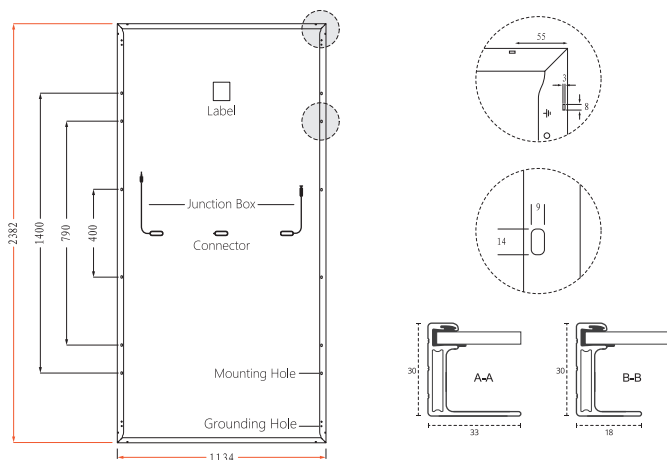

LECO laser assisted sintering technology,
reduces contact resistance and improves efficiency by 0.2% -0.5%

DHN-72R20 610~630W

Design

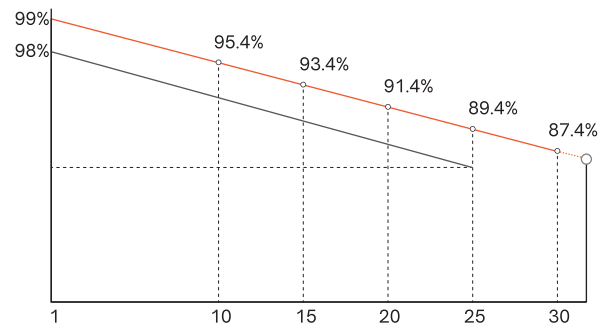

30-Year Linear Power Output Warranty



- DAH Solar linear power output guarantee
- Standard linear power output guarantee

Mechanical Specification

No. of Cells	144 (6×24)
Weight	27.2kg
Cells Type	N-type 182×95.8mm
Dimension (L×W×T)	2382×1134×30mm
Packing	36pcs/Pallet, 720pcs/40HQ

Cable	4.0mm ² , 300/200mm in length, (Including connector) length can be customized
Glass	3.2mm High Transmission, Antireflection Coating
Junction Box	IP68, 3 Bypass Diodes
Connector	MC4 Compatible

STC-Electrical Characteristics

Module Type	DHN-72R20				
		610	615	620	625
Maximum Power (P _{max} /W)	610	615	620	625	630
Open-circuit Voltage (V _{oc} /V)	52.4	52.6	52.8	53.0	53.2
Maximum Power Voltage (V _{mp} /V)	44.6	44.8	45.0	45.2	45.4
Short-circuit Current (I _{sc} /A)	14.72	14.78	14.84	14.90	14.96
Maximum Power Current (I _{mp} /A)	13.68	13.73	13.78	13.83	13.88
Module Efficiency (%)	22.58	22.77	22.95	23.14	23.32

STC-Standard Test Environment: Irradiance 1000W/m², Cell temperature 25°C, Spectrum AM1.5

NOCT-Electrical Characteristics

Maximum Power (P _{max} /W)	459	462	466	470	474
Open-circuit Voltage (V _{oc} /V)	49.8	50.0	50.2	50.4	50.5
Maximum Power Voltage (V _{mp} /V)	42.4	42.6	42.8	42.9	43.1
Short-circuit Current (I _{sc} /A)	11.88	11.93	11.98	12.03	12.08
Maximum Power Current (I _{mp} /A)	10.83	10.87	10.91	10.95	10.98

NOCT-Standard Test Environment: Irradiance 800W/m², Ambient temperature 20°C, Spectrum AM1.5, Wind speed 1m/s

Operating Parameters

Maximum System Voltage	1500V DC
Operating Temperature	-40 ~ +85°C
Maximum Series Fuse Rating	25A
Nominal Operating Cell Temperature	45°C±2°C
Application Level	Class A

Temperature Coefficient

Temperature Coefficient of I _{sc} (αI _{sc})	0.046%/°C
Temperature Coefficient of V _{oc} (βV _{oc})	-0.25%/°C
Temperature Coefficient of P _{max} (γP _{mp})	-0.29%/°C
Snow load, frontside / Wind load, backside	5400Pa/2400Pa